

- Das **LL232 Trunking-Träger-System** ist für alle LED-Module der LL232-Serie konstruiert
- Alle Profile aus Aluminium, **weiss** lackiert (RAL-Farben möglich)
- Durchgangsverdrahtung **9**-adrig oder **11**-adrig
- Einfache Click-Verbindungen, modularer Aufbau
- Module oder Elemente auch nachträglich austauschbar
- Dimmung und DALI-Steuerung vorbereitet
- Zubehör (Bewegungsmelder, TrackLight-Schiene etc.)
- Blind-Cover oder 3-Phasen-Stromschienenstrahler möglich
- Optional mit Alu-Reflektoren, 45°/75° oder 90°

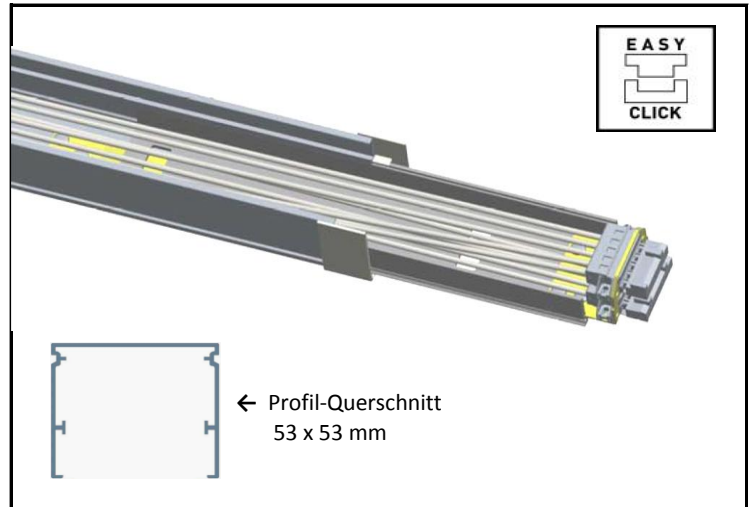

Busverdrahtung: 7x 2,5 mm<sup>2</sup> (L1, L2, L3, N, PE & Notstrom) & 2x 0,75 mm<sup>2</sup> (1-10V oder DALI) & 2x 0,75 mm<sup>2</sup> (Emergency)

### Umfangreiches Zubehör:

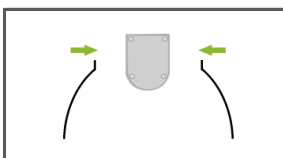
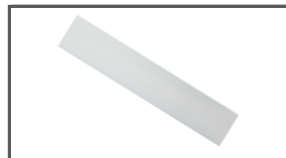
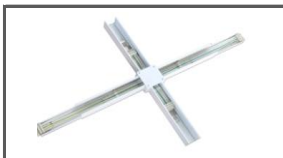
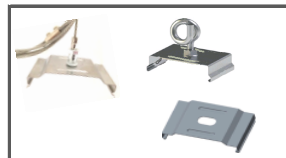
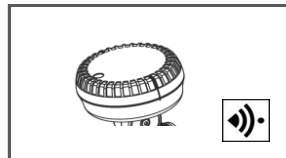

### EASY-CLICK & USE



### Bestellung | order

Match-Code	Bezeichnung <i>description</i>	Art.-Nr. <i>item number</i>	VE*	Größe <i>size [mm]</i> L x H x B	Gewicht <i>weight</i>		
1	AC-Einspeiser <b>500 / 9-adrig</b>	LL232-A-0056-SE-500-9	12362	1	500 x 53 x 53	420 g	7 plus 2 cable
2	Tragschiene <b>1000 / 9-adrig</b>	LL232-A-0057-TR-1000-9	12363	1	1000 x 53 x 53	1.155 g	7 plus 2 cable
3	Tragschiene <b>1500 / 9-adrig</b>	LL232-A-0040-TR-1500-9	12364	1	1500 x 53 x 53	1.580 g	7 plus 2 cable
	Tragschiene <b>3000 / 9-adrig</b>	LL232-A-0041-TR-3000-9	12365	1	3000 x 53 x 53	3.160 g	7 plus 2 cable
1	AC-Einspeiser <b>500 / 11-adrig</b>	LL232-A-00xx-SE-500-11	12xxx	1	500 x 53 x 53	440 g	7 plus 4 cable (emergency)
2	Tragschiene <b>1000 / 11-adrig</b>	LL232-A-00xx-TR-1000-11	12xxx	1	1000 x 53 x 53	1.200 g	7 plus 4 cable (emergency)
3	Tragschiene <b>1500 / 11-adrig</b>	LL232-A-0060-TR-1500-11	12xxx	1	1500 x 53 x 53	1.620 g	7 plus 4 cable (emergency)
	Tragschiene <b>3000 / 11-adrig</b>	LL232-A-0061-TR-3000-11	12xxx	1	3000 x 53 x 53	3.200 g	7 plus 4 cable (emergency)
4	Endkappe für Tragschiene	LL232-A-0027-EK	12366	1	12 x 53 x 53	12 g	1 Stück, Kunststoff weiss
5	Montage-Set "Decke"	LL232-A-0055-MD	12367	1	2er-Set	22 g	Clip für Deckenmontage
6	Montage-Set "Haken & Seil"	LL232-A-0059-MS	12368	1	2er-Set	58 g	für Seilabhängung, 140 cm
7	Montage-Haken-Set "Kette"	LL232-A-0058-MK	12369	1	2er-Set	60 g	Haken für Kettenabhängung
8	Knotenkette K-27, 30m-Bund	KNK-Stahl-K27-30-2.5-40kg	12370	1	30 m Ø 2,5 mm	4.450 g	verzinkt, tragfähig bis 40 kg
	Blindabdeckung <b>500 (Alu-Cover)</b>	LL232-A-0024-BL-500	12371	1	500 x 5 x 53	80 g	Aluminium, weiss
9	Blindabdeckung <b>1000 (Alu-Cover)</b>	LL232-A-0024-BL-1000	12372	1	1000 x 5 x 53	155 g	Aluminium, weiss
	Blindabdeckung <b>1500 (Alu-Cover)</b>	LL232-A-0024-BL-1500	12373	1	1500 x 5 x 53	230 g	Aluminium, weiss
	3-Phasen-Stromschiene <b>500</b>	LL232-A-0032-3P-500	12374	1	500 x 40 x 53	890 g	für Tracklights, 3-phasig
10	3-Phasen-Stromschiene <b>1500</b>	LL232-A-0033-3P-1500	12375	1	1500 x 40 x 53	2.700 g	für Tracklights, 3-phasig
	3-Phasen-Stromschiene <b>3000</b>	LL232-A-0034-3P-3000	12376	1	3000 x 40 x 53	5.400 g	für Tracklights, 3-phasig
	Alu-Reflektor-Set <b>45° *</b>	LL232-A-0028-RF-1500-45	12377	1	1500 x 75	1.200 g	2er-Set, innen Alu poliert
11	Alu-Reflektor-Set <b>75° *</b>	LL232-A-0053-RF-1500-75	12378	1	1500 x 75	1.200 g	2er-Set, innen Alu poliert
	Alu-Reflektor-Set <b>90° *</b>	LL232-A-0054-RF-1500-90	12379	1	1500 x 75	1.200 g	2er-Set, innen weiss lackiert

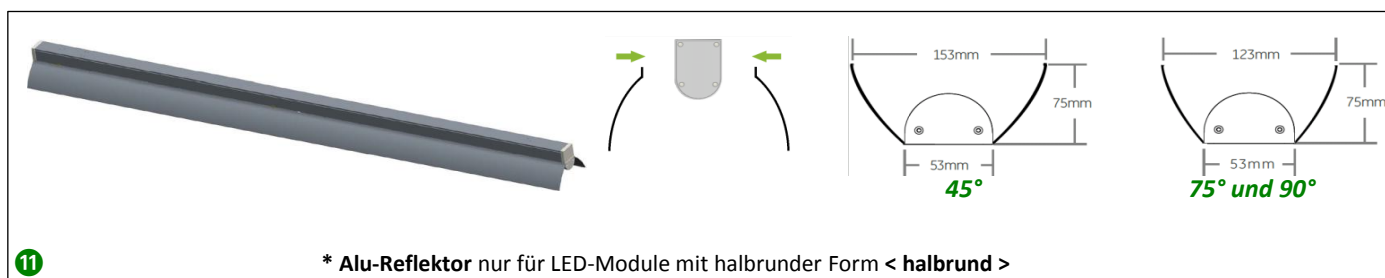

VE = Verpackungseinheit | packing unit

Bestellung | order

Match-Code	Bezeichnung description	Art.-Nr. item number	VE*	Größe size [mm] L x H x B	Gewicht weight		
15	Bewegungsmelder A		1	∅ 76 x 30		in Vorbereitung	
16	Präsenzmelder B		1			in Vorbereitung	
17	Multi-Sensor MS		1			in Vorbereitung	
18	DALI-Schnittstelle:  DALI-INTERFACE- 0-10V LE	12380	10	41 x 28 x 14,2	10 g	Lunatone, 0-10V (0-100%)	
	<i>Für diese 3 Komponenten ist mind. ein 50 cm Blindmodul erforderlich!</i>						
	Signalverstärker DALI	12514	40	189 x 30 x 30	187 g	OSRAM Verstärker für 1-10V	
	DALI Stromversorgung	12515	5	130 x 21 x 30	82 g	DALI-Spannungsversorgung	
19	Notstrom-Akkupack		10			in Vorbereitung	
L1	L-Verbinder L1-300 / 9-adrig	LL232-A-0042-TR-310-9-L1	12381	1	300 x 53 x 460	1.000 g	inkl. Blindabdeckung Alu weiss
L2	L-Verbinder L2-300 / 9-adrig	LL232-A-0043-TR-310-9-L2	12382	1	460 x 53 x 300	1.000 g	inkl. Blindabdeckung Alu weiss
T1	T-Verbinder T1-300 / 9-adrig	LL232-A-0044-TR-310-9-T1	12383	1	518 x 53 x 460	1.400 g	inkl. Blindabdeckung Alu weiss
T2	T-Verbinder T2-300 / 9-adrig	LL232-A-0045-TR-310-9-T2	12384	1	518 x 53 x 460	1.400 g	inkl. Blindabdeckung Alu weiss
T3	T-Verbinder T3-300 / 9-adrig	LL232-A-0046-TR-310-9-T3	12385	1	518 x 53 x 460	1.400 g	inkl. Blindabdeckung Alu weiss
X1	X-Verbinder X1-300 / 9-adrig	LL232-A-0048-TR-500-9-X1	12386	1	678 x 53 x 518	1.700 g	inkl. Blindabdeckung Alu weiss
X2	X-Verbinder X2-300 / 9-adrig	LL232-A-0049-TR-500-9-X2	12387	1			inkl. Blindabdeckung Alu weiss
X3	X-Verbinder X3-300 / 9-adrig	LL232-A-0050-TR-500-9-X3	12388	1			inkl. Blindabdeckung Alu weiss
X4	X-Verbinder X4-300 / 9-adrig	LL232-A-0047-TR-500-9-X4	12389	1			inkl. Blindabdeckung Alu weiss

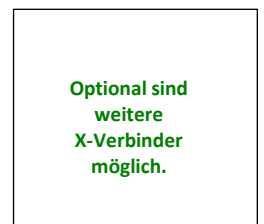
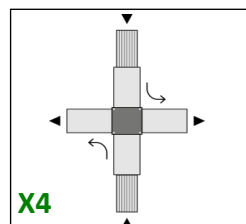
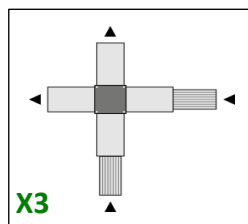
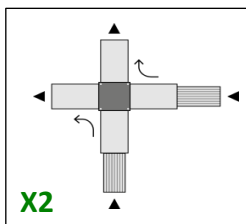
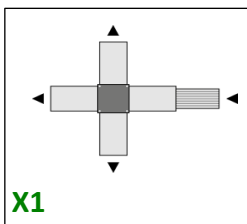
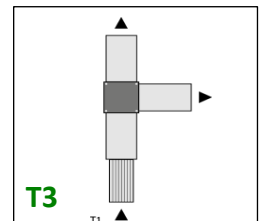
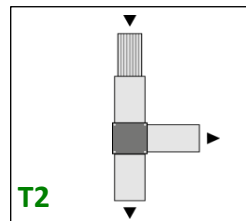
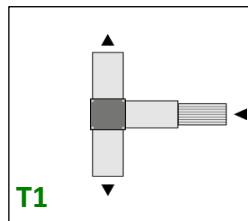
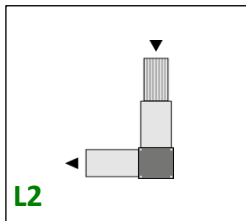
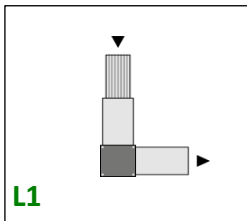
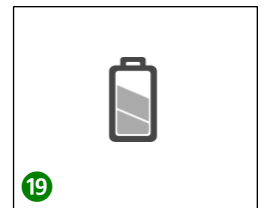
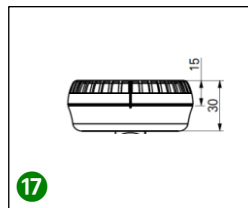
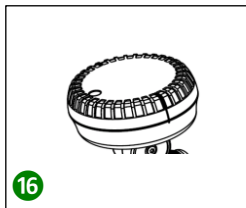

Alle Ansichten der Verbinder (L1 bis X4) sind von "OBEN" auf das geschlossene Profil betrachtet!

Connectors are from top view!

VE = Verpackungseinheit | packing unit

Erklärungen zu den Verbindern:

 AC-IN

 AC-Out